

Nicab Exact



The ballvalve with technology: Perfect for a wide range of applications

The 2- and 3-way ballvalves, in DZR (dezincification-resistant) brass, are the ideal combination in conjunction with the rotary drives and damper drives with spring return as option.

The new actuators makes it possible to use different characteristics together with the actuator or to adjust the running time for a certain application. Other outstanding features for the new ballvalves is manual adjustment, high control ratio of 50:1, working pressure of 40 bar and a maximum differential pressure of 6 bar.

Nicab Exact regulating ballvalve

Regulating ballvalve for continuous control of secondary refrigerants.

The valvebody in DZR brass is used in conjunction with Nicab Exact actuator for regulators with analog (output 0...10V) or switching output (2 -or 3- point control).

Actuator and valve is connected with a bayonet connection.

- Stepping motor with electronic control unit and maintenance-free gearbox
- The type of characteristic (linear / quadratic / equal-percentage) can be set on the rotary drive
- The mode of action can be changed over directly at the cable
- Electronic load-dependent shut-off by means of stops in the drive
- Coding switches for selecting the characteristic curve and the running time (35 s, 60 s, 120 s)
- Gearbox that can be disengaged for manual ball valve positioning (with manual lever)
- Tool-less assembly with ball valve
- Installation position: vertically upright to horizontal, not suspended



T10644



T10647



Art. Nr.	Description	DN	Connection	Kvs	Voltage	Running time / sec.	Weight kg
NEV215	2-way regulating ballvalve	15	Rp 1/2"	6,3	24 V ~/=	35 / 60 / 120	0,99
NEV220	2-way regulating ballvalve	20	Rp 3/4"	10	24 V ~/=	35 / 60 / 120	1,02
NEV225	2-way regulating ballvalve	25	Rp 1"	16	24 V ~/=	35 / 60 / 120	1,19
NEV232	2-way regulating ballvalve	32	Rp 1 1/4"	25	24 V ~/=	35 / 60 / 120	1,43
NEV240	2-way regulating ballvalve	40	Rp 1 1/2"	40	24 V ~/=	35 / 60 / 120	1,80
NEV250	2-way regulating ballvalve	50	Rp 2"	63	24 V ~/=	35 / 60 / 120	2,46
NEV315	3-way regulating ballvalve	15	Rp 1/2"	4	24 V ~/=	35 / 60 / 120	1,1
NEV320	3-way regulating ballvalve	20	Rp 3/4"	6,3	24 V ~/=	35 / 60 / 120	1,2
NEV325	3-way regulating ballvalve	25	Rp 1"	10	24 V ~/=	35 / 60 / 120	1,6
NEV332	3-way regulating ballvalve	32	Rp 1 1/4"	16	24 V ~/=	35 / 60 / 120	2,0
NEV340	3-way regulating ballvalve	40	Rp 1 1/2"	25	24 V ~/=	35 / 60 / 120	2,3
NEV350	3-way regulating ballvalve	50	Rp 2"	63/40	24 V ~/=	35 / 60 / 120	3,0

Positioner*

Control signal	0...10V, Ri > 100 kΩ	Start point U0	0 eller 10 V
Position feedback signal	0...10V, last > 10 kΩ	Control span ΔU	10 V
Power consumption	4,9 W 8,7 VA	Switching range Xsh	200 mV
Supply voltage	24V~ ± 20%, 50...60 Hz 24V=** + 20% / - 10%	Protection class (horizont.)	IP54
Max. medium temp. ***	100 °C	Protection class	III
Perm. ambient temp.	-10...55 °C	Response time *	200 ms
Perm. ambient humidity:	5...95% rh without condensation		

Operating temp.	-10...130 °C	Additional info:
Operating pressure	-10...50 °C 40 bar +130 °C 35 bar	
Valve characteristic	Equal-percentage	
Ball valve rangeability	500:1 (typical)	
Rangeability with drive	> 100:1 (typical)	
Leakage rate	0,001% of kvs value	
Rotation angle	90°	

* Also for 2-point or 3-point depending on connection type

** 24V = for all functions

*** For medium temp >100 °C use appropriate accessorie 0510420 001

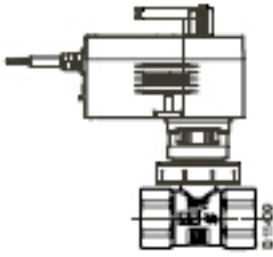

Combination of NEV and rotary drive

Drive unit	AKM115S		
Modell:	AKM115S		
Running time:	60s / 120s		
Control:	0...10V, 2/3 point		
Ventil	against pressure		
	Δp max	Δp_s	close off pressure
NEV215	3,5	-	-
NEV220	3,5	-	-
NEV225	3,5	-	-
NEV232	2,4	-	-
NEV240	2,4	-	-
NEV250	2,4	-	-
NEV315			
NEV320			
NEV325			
NEV332			
NEV340			
NEV350			

Actuator function

Depending on the type of connection (see connecting plan) the drive can be used as a continuous 0...10V drive or a 2-point (open/closed) or 3-point (open/stop/closed) drive with intermediate position. The running time of the drive can be set in accordance with requirements using coding switches. The equal-percentage, linear or quadratic characteristic curve can be selected using the coding switches. The AKM 115 is combined with ball valves with an equal percentage basic characteristic curve like the NEV 2 or 3 way valves. Manual adjustment takes place by disengaging the gearbox (slide switch next to connecting cable) and simultaneous rotation using the manual adjusting lever. The drive position is indicated by the manual adjusting lever or the indicator knob on the upper part of the drive. Attention: return slide switch after making manual adjustment (engage gearbox).

Connection as 2-point valve drive

This open/closed actuation can take place via 2 cables. The drive is connected to the voltage via the blue and brown cables. The control branch of the ball valve is opened by applying voltage to the black cable. When this voltage is switched off, the drive moves to the opposite end position and closes the ball valve.

The unused red and grey lines must not be connected or come into contact with other cables. We recommend that these cables be isolated.

Connection as 3-point actuator

The ball valve can be moved to any position by applying voltage to the brown or black cable. Direction of rotation (viewed from drive to ball valve spindle):

- axle rotates clockwise with voltage applied to brown cable, closes the ball valve.
- axle rotates anticlockwise with voltage applied to black cable.

In the end positions (stop in drive, maximum rotation angle of 95 ° reached) or in the event of overloading the electric motor shut-off mechanism is activated (not a limit switch). The rotating angle can be changed by swapping the cables.

The unused red and grey lines must not be connected or come into contact with other cables. We recommend that these cables be isolated.

Connection for 0...10V control voltage

The built-in positioner controls the drive depending on the controller output signal y .













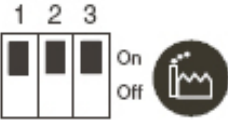
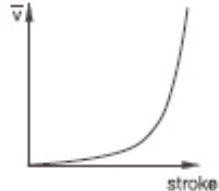
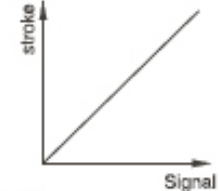
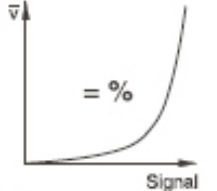

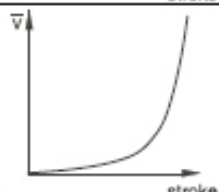
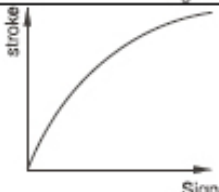
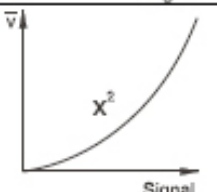
Direction of rotation (viewed from drive to ball valve spindle): Mode of action 1 (mains voltage applied to brown cable):

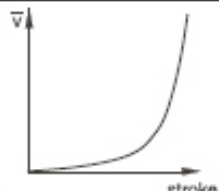
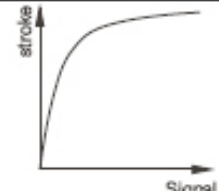
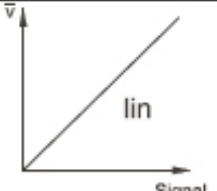
As the output signal increases, the driver axle rotates anticlockwise and opens the control passage of the ball valve.

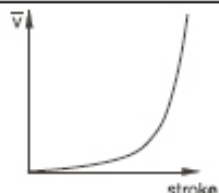
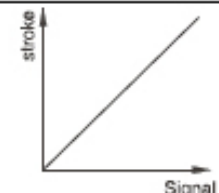
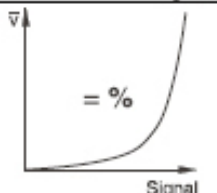
Mode of action 2 (mains voltage applied to black cable): As the output signal increases, the driver axle rotates clockwise and closes the control passage of the ball valve. The start point and the control span are fixed. Voltage must only be applied to either the brown cable or the black cable. The cable that is not used must be isolated (if not connected to a switch). Since the start point and the control span are fixed, a split range unit is needed to adjust partial ranges (accessory). After manual adjustments or if the voltage has been interrupted for more than 5 minutes the drive recalibrates itself, with a running time of 60 s in all cases. When the supply voltage is applied the stepping motor moves to the 100% position, makes the connection to the driver axle, moves to the 0% position and therefore defines the operating range. It is then possible to move to any position between a rotation angle of 0 and 90 °, depending on the control voltage. Thanks to the electronics no steps are lost, and the drive does not require occasional recalibration. The parallel running of several drives of this type is guaranteed. The positional feedback $y_0 = 0...10V$ corresponds to the effective rotation angle of 0 to 90 °. If the 0...10V control signal is interrupted and mode of action 1 is connected, the ball valve is fully closed (0% position). The characteristic curve of the ball valve can be selected using the coding switch. Characteristic curves can only be generated if the drive is used as a continuous drive. The running times can be selected using other switches. These can be used regardless of whether the 2-point, 3-point or continuous function has been selected.

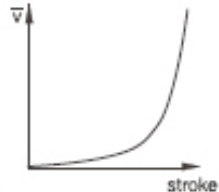
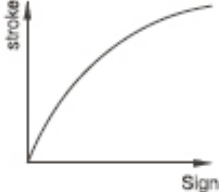
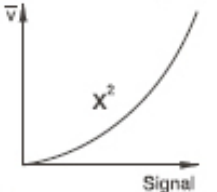
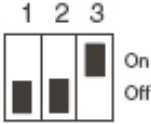
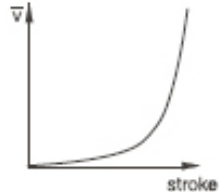
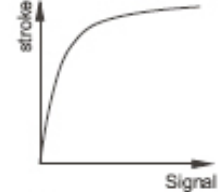
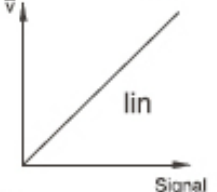
FlowControl

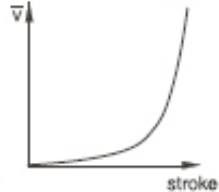
Switch for running time and characteristics

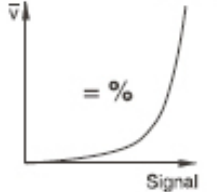
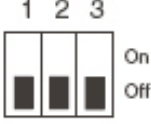
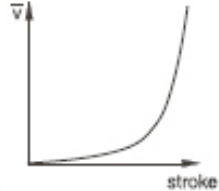
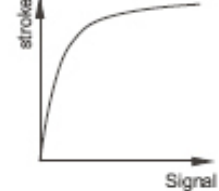
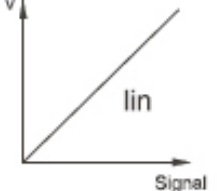
Kodomkopplare				Gångtid/vridvinkel s/90°
				120 s ± 4
				120 s ± 4
				120 s ± 4
				60 s ± 2
				60 s ± 2
				60 s ± 2
				35 s ± 1
				35 s ± 1

Valve function

The control ball valve can be controlled to any intermediate position using an electric drive. Closing against the operating pressure is possible with the AKM 105, 115(S) drive or the valve drive with spring return AKF 112, 113(S), and closing with the operating pressure is not permitted.

Closing against the pressure



Description

These control ball valves are characterised by being extremely reliable and accurate, and make a considerable contribution to providing environmentally friendly control. They comply with the most demanding requirements such as a quick-closing function, coping with differential pressures, controlling media temperatures and providing a shut-off facility – all with a low-noise design. The spindle of the ball valve is automatically connected to the axle carrier of the drive. The brass ball regulates an equal-percentage flow in the control branch. The tightness of the ball is safeguarded by the Teflon collar that is inserted into the body. An EPDM O-ring is inserted behind these two collars. These O-rings permit the ball and both collars to make a small axial movement that provides an extremely good seal and generates little torque.

The tightness of the spindle is safeguarded by 2 O-rings that cannot be replaced if leakage occurs.

Engineering and fitting notes

The valves are combined with the rotary drives with or without spring return. The drive is directly attached to the ball valve and held in place by a bayonet connection. The drive axle is connected to the spindle automatically, for which purpose the axle of the ball valve must be in an intermediate position. During the commissioning of the system the drive moves to the open position and both devices are connected automatically. The rotation angle of the ball valve is also detected by the drive, meaning that no other settings are required. The characteristic curve of the drives can be set to linear or quadratic. In order to prevent the ball valve from blocking in the final position, the drive makes a rotation angle movement of approx. 30° if the output signal has not changed at the final positions for about 3 days.

In order to prevent impurities from being retained in the water (e.g. welding beads, rust particles etc.) and damaging the Teflon collar, strainers must be installed on each floor or in each feed pipe. For strainers see accessories, pay attention to usage and temperature range for each model. For water requirements see VDI 2035.

All ball valves must only be used in closed circuits. Excessive oxygen content in open circuits can destroy the valve. In order to prevent this, an oxygen binding material must be used; the manufacturer of the solution must be consulted with regard to compatibility in order to prevent corrosion. The material list can be used for this purpose.

The fittings are usually insulated in the systems. Care must be taken not to insulate the flange that holds the drive when doing this. In order to prevent disturbing flow noise in quiet rooms, the pressure difference across the valve must not exceed 50% of the specified values. The crank handle is fixed to the drive. In order to operate the crank handle the manual adjustment knob on the drive must be pushed downwards. The drive will not operate until this knob is moved back to the upper position. There is also a square on the crank handle that matches the square of the ball valve spindle.

Use with water

When water is being used that has been mixed with glycol or inhibitor, compatibility with the materials and seals in the valve should be clarified with the manufacturer for safety reasons. We recommend using a concentration of between 20% and 55% when glycol is being used.

The valves are not suitable for use in potentially explosive areas. The materials that have been selected are approved for use with drinking water. The entire valve as a unit is not certified for use with drinking water.

Installation position

The final control element can be installed in any position, but a suspended installation position is not recommended. Condensation and dripping water must be prevented from penetrating the drive.

Dimensions

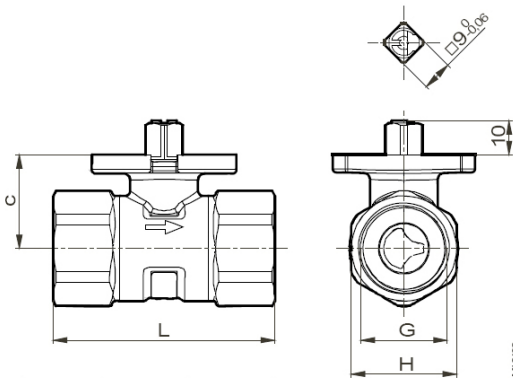

DN	c mm	G tum	L mm	H mm
15	27,6	Rp ½	61,6	26
20	27,6	Rp ¾	67,4	31
25	30,5	Rp 1	76,8	39
32	34,3	Rp 1¼	88,0	48
40	39,8	Rp 1½	101,8	55
50	52,8	Rp 2	115,6	67

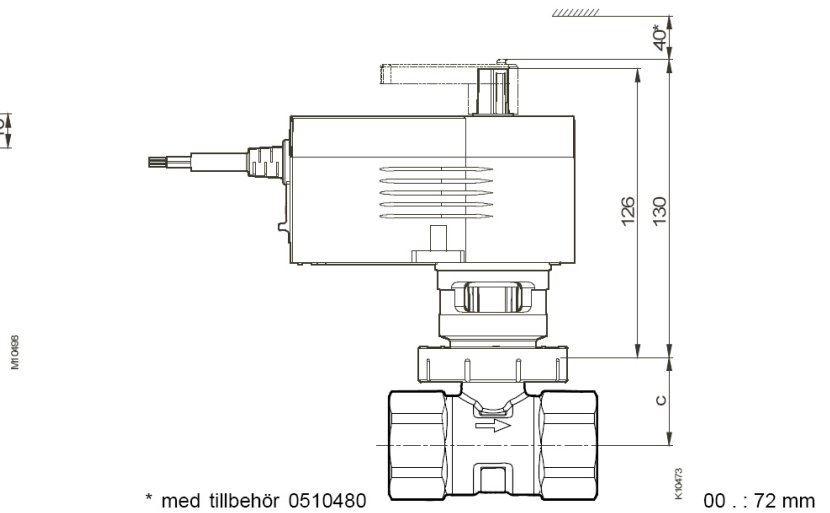

Electrical scheme

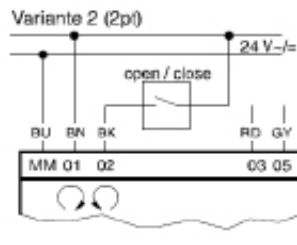
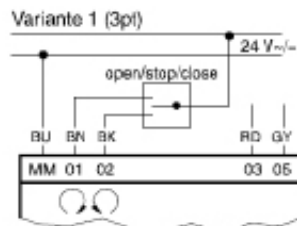
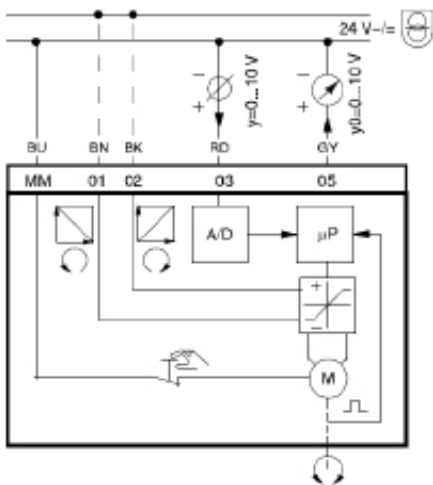

BU= Blue
 BN= Brown
 BK = Black
 RD= Red
 GY = Gray

MM = Neutral
 01 = 24V power for 0..10V control
 02 = 24V power for 10...0V control
 03 = 0-10V Signal (same potential as the neutral)
 05 = Feedback signal